

FORI ESAGONALI  
M5 DIAM.7,2MM

FORI ESAGONALI  
M5 DIAM.7,2MM

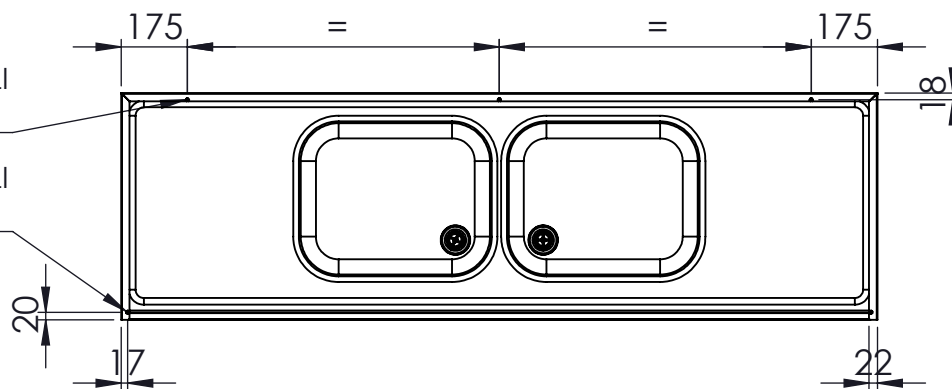

DISEGNATO	
DATA	11/01/2024
PESO	24754.21

CODICE: **M100**



CONFIGURAZIONE: **L:2000 P:600**

SCALA: 1:20

A4

FOGLIO 1 DI 1